



INSTRUCTION MANUAL

VHF MARINE TRANSCEIVER

IC-M45A

Icom Inc.

FOREWORD

Thank you for purchasing this Icom product. The IC-M45A VHF MARINE TRANSCEIVER is designed and built with Icom's superior technology and craftsmanship. With proper care this product should provide you with years of trouble-free operation.

IMPORTANT

READ ALL INSTRUCTIONS carefully and completely before using the transceiver.

SAVE THIS INSTRUCTION MANUAL—This instruction manual contains important operating instructions for the IC-M45A.

EXPLICIT DEFINITIONS

WORD	DEFINITION
⚠ WARNING	Personal injury, fire hazard or electric shock may occur.
CAUTION	Equipment damage may occur.
NOTE	If disregarded, inconvenience only. No risk of personal injury, fire or electric shock.

FEATURES

-  **Durable, water-resistant construction**
Built tough to withstand the punishing marine environment, the IC-M45A offers reliability you can count on.

-  **Dual watch and tri-watch functions**
Convenient functions which allow you to monitor the distress channel (ch 16) while receiving a channel of your choice—dual watch; or monitor the distress channel and another channel while receiving a channel of your choice—tri-watch.

-  **Large, easy-to-read LCD**
With dimensions of 20(H) × 60(W) mm, the IC-M45A's function display is easy to read and shows operating conditions at a glance. Backlighting and contrast can be adjusted to suit your preferences.

-  **'Smart' microphone**
Operating channel and transmit output power level settings are easily selectable via the supplied microphone.

-  **Simple operation**
Ergonomic design with a minimum number of switches and controls provides simple intuitive operation.

CAUTIONS

⚠ WARNING! NEVER connect the transceiver to an AC outlet. This may pose a fire hazard or result in an electric shock.

⚠ WARNING HIGH VOLTAGE! NEVER touch the antenna or an internal antenna connector during transmission. This may result in an electric shock or a burn.

NEVER connect the transceiver to a power source of more than 16 V DC. This connection will ruin the transceiver.

AVOID using or placing the transceiver in direct sunlight or in areas with temperatures below -20°C (-4°F) or above $+60^{\circ}\text{C}$ ($+140^{\circ}\text{F}$).

DO NOT operate the transceiver without running the vessel's engine. When your vessel's engine is OFF and the transceiver is transmitting, the vessel's battery will soon become exhausted.

KEEP the transceiver out of the reach of children.

KEEP the antenna cable and DC power cable as far away as possible from electrical pumps, generators and other electronic instruments to prevent instrument malfunctions.

KEEP the transceiver and microphone at least 1 meter away from your vessel's magnetic navigation compass.

IN CASE OF EMERGENCY

If your vessel requires assistance, contact other vessels and the Coast Guard by sending a distress call on channel 16.

○ **USING CHANNEL 16**

DISTRESS CALL PROCEDURE

1. "MAYDAY MAYDAY MAYDAY."
2. "THIS IS" (name of vessel)
3. Your call sign or other indication of the vessel.
4. "LOCATED AT" (your position)
5. The nature of the distress and assistance required.
6. Any other information which might facilitate the rescue.

TABLE OF CONTENTS

FOREWORD	ii	4 SET MODE	11–12
IMPORTANT	ii	■ Entering SET mode	11
EXPLICIT DEFINITIONS	ii	■ SET mode items	11
FEATURES	ii	5 CONNECTIONS AND MAINTENANCE	13–16
CAUTIONS	iii	■ Unpacking	13
IN CASE OF EMERGENCY	iii	■ Antenna	13
TABLE OF CONTENTS	iv	■ Fuse replacement	13
1 OPERATING RULES	1	■ Cleaning	13
2 PANEL DESCRIPTION	2–4	■ Connections	14
■ Front panel	2	■ Mounting the transceiver	15
■ Microphone	3	■ Dimensions	16
■ Function display	4	6 TROUBLESHOOTING	17
3 BASIC OPERATION	5–10	7 VHF MARINE CHANNEL LIST	18
■ Power ON	5	8 SPECIFICATIONS AND OPTIONS	19
■ Channel selection	5	■ Specifications	19
■ Receiving	7	■ Options	19
■ Transmitting	8		
■ Scan function	9		
■ Call channel programming	10		
■ Display backlighting	10		

◇ Priorities

- Read all rules and regulations pertaining to priorities and keep an up-to-date copy handy. Safety and distress calls take priority over all others.
- You must monitor channel 16 when you are not operating on another channel.
- False or fraudulent distress calls are prohibited under law.

◇ Privacy

- Information overheard but not intended for you cannot lawfully be used in any way.
- Indecent or profane language is prohibited.

◇ Radio licenses

SHIP STATION LICENSE

When your craft is equipped with a VHF FM transceiver, you must have a current radio station license before using the transceiver. It is unlawful to operate a ship station which is not licensed.

Inquire through your dealer or the appropriate government agency for a Ship-Radiotelephone license. This license includes the call sign which is your craft's identification for radio purposes.

OPERATOR'S LICENSE

A restricted Radiotelephone Operator Permit is the license most often held by small vessel radio operators when a radio is not required for safety purposes.

The Restricted Radiotelephone Operator Permit must be posted near the transceiver or be kept with the operator. Only a licensed radio operator may operate a transceiver.

However, non-licensed individuals may talk over a transceiver if a licensed operator starts, supervises, ends the call and makes the necessary log entries.

A current copy of the applicable government rules and regulations is only required to be on hand for vessels in which a radio telephone is compulsory. However, even if you are not required to have these on hand it is your responsibility to be thoroughly acquainted with all pertinent rules and regulations.

NOTE: Even though the IC-M45A is capable of operation on VHF marine channels 3, 21, 23, 61, 64, 81, 82 and 83, according to FCC regulations these channels cannot be lawfully used by the general public in USA waters.

■ Front panel

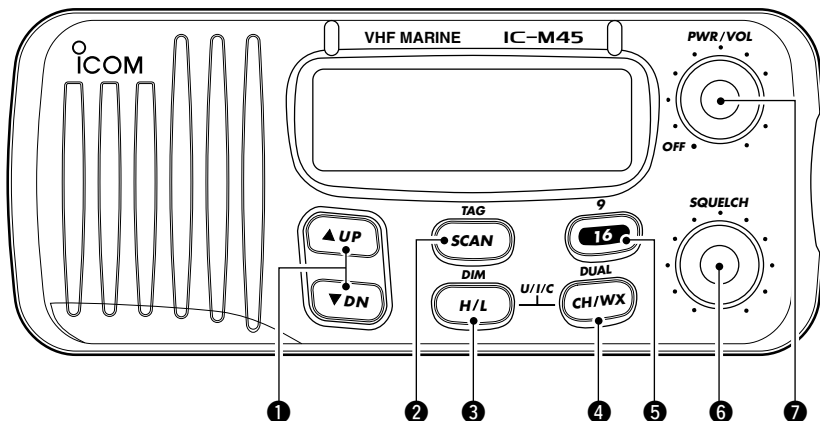

① CHANNEL UP/DOWN SWITCHES [▲UP]/[▼DN]

Push to select an operating channel. (p. 6)

- Push and hold to 'speed' scroll up or down through the available channels.

② SCAN SWITCH [SCAN • TAG]

➔ Push to start/stop scanning. (p. 9)

- Scan type can be selected in SET mode. (p. 12)

➔ Push for 1 sec. to toggle the tag setting for the displayed channel. (p. 9)

③ HIGH/LOW POWER SWITCH [H/L • DIM]

➔ Toggles between high and low output powers. (p. 8)

- ➔ While pushing, push the [UP]/[DN] switches to adjust the display backlighting. (p. 10)
- ➔ While pushing, push [SCAN] for 3 sec. to clear all tag channels. (p. 9)

④ CHANNEL SWITCH [CH/WX • DUAL]

➔ Push to toggle between regular channel mode and weather channel mode. (p. 6)

- While in regular channel mode, push [H/L] + [CH/WX] to change channel groups.

- ➔ Push for 1 sec. to start/stop dual (tri) watch. (p. 7)
 - Use SET mode to select dual or tri-watch in advance. (p. 12)

5 CHANNEL 16 SWITCH [16 • 9]

- ➔ Push to select channel 16. (p. 5)
- ➔ Push for 1 sec. to select the call channel (channel 9 by default). (p. 5)
 - Each group can have it's own call channel programmed.
- ➔ Push for 3 sec. (when a call channel is selected) to enter call channel write mode. (p. 10)
 - Channel indication flashes.

6 SQUELCH CONTROL [SQUELCH]

Rotate clockwise to eliminate audio noise. (p. 7)

7 POWER/VOLUME CONTROL [PWR/VOL]

Turns power ON and OFF and adjusts the audio output level.

Microphone

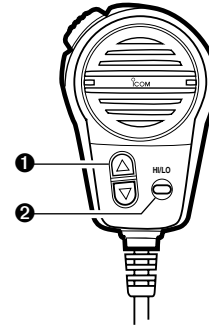

1 CHANNEL UP/DOWN SWITCHES [▲]/[▼]

Select an operating channel in the selected channel group.

- These switches can be used instead of the transceiver's [UP]/[DN] switches.

2 HIGH/LOW POWER SWITCH [HI/LO]

The same function as the transceiver's [H/L] switch—toggles between high and low output powers.

- Pushing this key at power ON turns the microphone keys ON/OFF.

2 PANEL DESCRIPTION

■ Function display

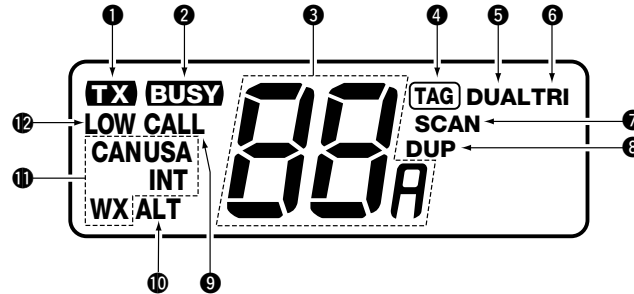

① TRANSMIT INDICATOR

Appears while transmitting. (p. 8)

② BUSY INDICATOR

Appears when receiving a signal or when [SQUELCH] is rotated too far clockwise. (p. 7)

③ CHANNEL INDICATOR

Shows the operating channel (pgs. 5, 6)

④ TAG CHANNEL INDICATOR

Appears when the selected channel is set as a tag channel. (p. 9)

⑤ DUALWATCH INDICATOR

Appears and flashes during dualwatch operation. (p. 7)

⑥ TRI-WATCH INDICATOR

Appears and flashes during tri-watch operation. (p. 7)

⑦ SCAN INDICATOR

Appears and flashes during scan operation. (p. 9)

⑧ DUPLEX INDICATOR

Appears when the selected channel is a duplex channel. (p. 6)

⑨ CALL CHANNEL INDICATOR

Appears when the call channel is selected. (p. 5)

⑩ WEATHER ALERT INDICATOR

“ALT” appears when a weather alert function is turned ON. (pgs. 6, 12)

⑪ MODE INDICATORS (p. 5, 6)

- “USA” shows that USA channels are selected.
- “CAN” shows that Canadian channels are selected.
- “INT” shows that international channels are selected.
- “WX” shows that weather channels are selected.

⑫ LOW POWER INDICATOR

Shows that low output power is selected. (p. 8)

■ Power ON

- ① Rotate [PWR/VOL] clockwise to turn power ON.



All display indications appear briefly.



Channel 16 is automatically selected.

- ② Operate the transceiver as indicated in the following sections.

◇ Low voltage indicator

When “b” appears and flashes as shown at right, there is a DC power source problem. In this case, check your vessel’s battery and DC power cable.



■ Channel selection

◇ Channel 16

Channel 16 is the distress channel. It is used for establishing initial contact with another station and for emergency communications. Channel 16 is monitored during dual/tri-watch. While standing by you are required to monitor channel 16.



or hang the microphone on the microphone hanger.

◇ Call channel

The call channel is used to store your most often-used channel for quick recall. In addition, the call channel is monitored during tri-watch. The default setting for the call channel is channel 9 which is for leisure boat use. A separate call channel can be set for each channel group (USA, CAN and INT).



for 1 sec.

“CALL” indicates that the call channel is selected.

3 BASIC OPERATION

◇ USA, Canadian and international channels

There are 57 USA, 57 Canadian and 57 international channels. These channel groups may be specified for the operating area.

- ① Push [CH/WX] to select a regular channel.
 - If regular channels (USA, CAN or INT) are already selected, this step is not necessary.
- ② Push [UP]/[DN] to select a channel.
 - “DUP” appears for duplex channels.
- ③ To change the channel group, while push and hold [H/L] push [CH/WX] simultaneously.
 - USA, Canadian and international channels can be selected in sequence.

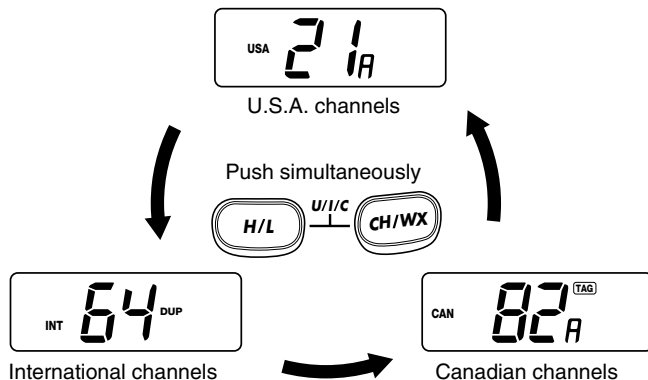

◇ Weather channels

There are 10 weather channels. These are used for monitoring NOAA (National Oceanographic and Atmospheric Administration) weather broadcasts.

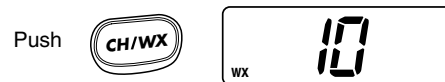

✓ CONVENIENT

Weather alert function: NOAA broadcast stations transmit a weather alert tone before important weather announcements.

- When the weather alert function is turned ON the “ALT” indicator appears on the display.
- When the alert signal is received “ALT” flashes with an alert tone and then weather announcements start.

This function is activated when a weather channel is selected or during any scan. See “SET mode items” on p. 12.

■ Receiving

- ① Rotate [PWR/VOL] to turn power ON.
- ② Rotate [SQUELCH] fully counterclockwise.
- ③ Adjust [PWR/VOL] to a suitable listening level.
- ④ Rotate [SQUELCH] clockwise until the audio noise disappears.
- ⑤ Select a channel. See pgs. 5–6 for details.
 - When a signal is received:
 - The squelch opens.
 - Audio is emitted from the speaker.
 - “BUSY” appears in the function display.
- ⑥ When an interrupting signal is received, rotate [SQUELCH] deeply clockwise.

◇ Dual/tri-watch functions

These functions allow you to conveniently check the distress channel (ch 16) or, both the distress and leisure call channel (ch 9; programmable) while receiving another channel. When receiving a signal on one of these channels, the transceiver stops on the channel until the signal disappears.

Depending on your preference, select dual watch or tri-watch in advance in SET mode (p. 12). Dual watch is the default setting.

When dual watch is selected in SET mode:

- ➡ Push [CH/WX • DUAL] for 1 sec. to start dual watch.



Checking channel 16 every 2 sec.

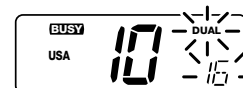

When receiving a signal on channel 16, channel 16 is monitored until the signal disappears.

When tri-watch is selected in SET mode:

- ➡ Push [CH/WX • DUAL] for 1 sec. to start tri-watch.



Checking channel 16 and the call channel every 2 sec.



When receiving a signal on the call channel, the call channel is monitored while checking ch 16 in 2 sec. intervals.

When receiving a signal on channel 16, channel 16 has priority.

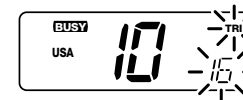

- ➡ Push any switch to cancel dual/tri-watch and return to normal operation.

3 BASIC OPERATION

■ Transmitting

Before transmitting, read the call procedures at right.

- ① Select an operating channel. See pgs. 5–6 for details.
- ② Push [H/L] to select a transmit output power.
 - “LOW” appears when low output power is selected.
 - High power cannot be selected on some channels. Refer to the channel list on p. 18.
- ③ Push and hold the [PTT] switch to transmit.
 - “**T X**” appears.
- ④ Speak into the microphone at your normal voice level.
 - Do not hold the microphone too closely to your mouth or speak too loudly. This may distort the signal.
- ⑤ Release the [PTT] switch to receive.

 **IMPORTANT:** In order to maximize the readability of your transmitted signal, pause for a moment after pushing [PTT], hold the microphone 15–20 cm from your mouth, then speak into the microphone at an even, normal voice level.

MOMENTARY HIGH POWER

On USA channels 13, 15 and 67, transmission using high power is momentarily possible. To use high power, push and hold [H/L] while transmitting.

CALL PROCEDURES

You must identify yourself when you transmit and you must respect time limits.

- 1) Give your call sign each time you call another vessel or a coast station. If you have no call sign, identify the station by giving the vessel name and the name of the license.
- 2) Give your call sign at the end of each transmission that lasts more than 3 minutes.
- 3) You must pause and give your call sign at least once every 15 minutes during long ship-to-shore calls.
- 4) Keep your calls short (less than 3 minutes). Wait 2 minutes before repeating a call.
- 5) Unnecessary transmissions are not allowed.

TIME-OUT TIMER (USA version only)

The transceiver has a time-out timer function to prevent continuous, long transmissions. Transmit is automatically inhibited after 5 min. of continuous transmission.

■ Scan function

The transceiver has a high speed scan function for standing by on utility signals. The scan speed is 8 channel/sec. (except when the weather alert function is in use).

Two scan types are available: *normal scan* (scans all tag channels in sequence) and *priority scan* (checks channel 16 while scanning). These scans can be selected in SET mode (p. 12).

◇ Setting tag channels

You can specify channels as tag channels for efficient scanning. Tag channels can be set for each channel group (USA, CAN, INT) independently.

- Select the desired channel, then push [SCAN • TAG] for 1 sec. to toggle the tag setting.

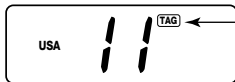

Appears when the channel is specified as a tag channel.

✓ Clearing all tag channels

While pushing [H/L] push [SCAN • TAG] for 3 sec. until the long beep becomes 2 short beeps.

- All tag channels in the selected channel group are released.

◇ Scan operation

- ① Select the desired channel group (USA, CAN, INT or WX) channels with [H/L] + [CH/WX] (or [CH/WX] only for weather channels).
 - When the weather alert function is in use, select the desired WX channel in the display, then perform the above step.
- ② Push [SCAN] to start scanning.
 - “SCAN” appears and flashes in the function display.
 - “16” appears during priority scan.
- ③ To stop the scan, push [SCAN] again.
 - “SCAN” disappears.

✓ Scan resume timer

When a signal is detected, scan pauses until the signal disappears or resumes after pausing 5 sec., according to the SET mode setting. (p. 12)

✓ Confirming tag channels

While operating scan, push [UP] or [DN].

- Only tag channels are selected.
- Stop pushing [UP] or [DN] to resume scan.

✓ Weather alert function

When this function is turned ON (p. 12), the selected weather channel is checked during scan. Refer to p. 6 for a description of weather alert.

3 BASIC OPERATION

■ Call channel programming

Pushing [16 • 9] for 1 sec. selects the call channel, channel 9 by default, however you can program your most often-used channels in each channel group for quick recall.

- ① While push and hold [H/L] push [CH/WX] one or more times to select the desired channel group (USA, CAN, INT) to be programmed.
- ② Push [16 • 9] for 1 sec. to select the call channel of the selected group.
 - “CALL” and the call channel number appear.
- ③ Push [16 • 9] for 3 sec. to enter call channel write mode.
 - Call channel and channel group to be programmed flash.
- ④ Push [UP] or [DN] to select the desired channel.

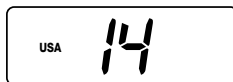

- ⑤ Push any switch to automatically program the selected channel.



- The transceiver returns to normal operation.

■ Display backlighting

The function display and switches can be backlit for better visibility under low light conditions.

While pushing [H/L • DIM], push [UP] or [DN] to adjust the backlighting.

- Backlighting can be set to 1 of 4 intensities or turned OFF.

■ Entering SET mode

SET mode is used to customize operation of the transceiver to suit your operating needs.

◇ To enter SET mode:

- ① While pushing [16], turn power ON.
 - Keep pushing [16] until the initial SET mode display appears.
 - SET mode is selected.
- ② To exit SET mode, turn power OFF then ON again.

◇ To select an item:

There are 5 items in SET mode that may be adjusted to suit your operating needs.

- ① Select SET mode as above.
- ② Push [16] to select an item; then push [UP]/[DN] to set the condition for the item.

■ SET mode items

The diagram illustrates five SET mode items, each shown in its default condition. To the left of the items is a button labeled '16' with an upward arrow, and the text 'Select a SET mode item*2'. To the right of each item is its name and a reference to page 12. Below the items are two buttons, '▲ UP' and '▼ DN', and a circular arrow icon with the text 'Select a SET mode condition*1'.

	Beep tones (p. 12)
	Normal/priority scan (p. 12)
	Weather alert (p. 12)
	Scan timer (p. 12)
	Dual/tri-watch (p. 12)

SET mode items above are shown at their default conditions.

4 SET MODE

◇ BEEP TONES

This item sets the transceiver's confirmation beep tones (when pushing a switch) ON or OFF.

Beep tones ON (default)



Beep tones OFF



◇ NORMAL/PRIORITY SCAN

This item sets the scan function to normal or priority operation. (See p. 9)

Normal scan (default)



Priority scan

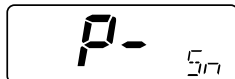

◇ WEATHER ALERT

This item sets the weather alert function ON or OFF. (p. 6)

Weather alert OFF (default)



Weather alert ON



◇ SCAN TIMER

This item sets the scan timer ON or OFF.

Scan timer OFF (default)



Scan timer ON



- Scan pauses on a signal until the signal disappears, and resumes 3 sec. after that.

- Scan pauses on a signal and resumes 5 sec. later.

◇ DUAL/TRI-WATCH

This item sets the [CH/WX • DUAL] switch to activate dual watch or tri-watch. (p. 7)

Dual watch (default)

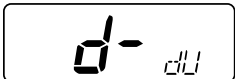

Tri-watch

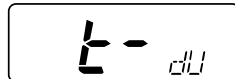

■ Unpacking

① Mounting bracket	1
② DC power cable (OPC-891)	1
③ Microphone hanger	1
④ Mounting bracket knobs	2
⑤ Mounting screws (5 × 20)	2
⑥ Mic hanger screws (3 × 16)	2
⑦ Flat washers (M5)	2
⑧ Spring washers (M5)	2

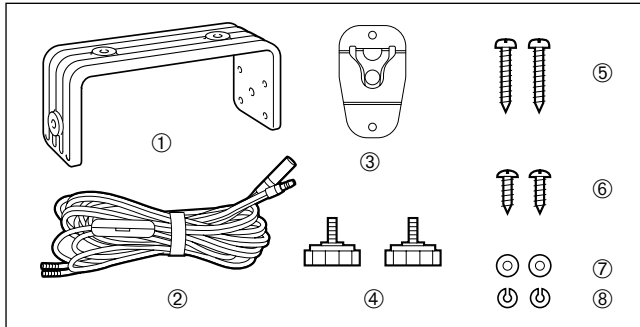

■ Antenna

A key element in the performance of any communication system is an antenna. Ask your Dealer about antennas and the best places to mount them.

■ Fuse replacement

Two fuses are installed in the supplied DC power cable. If a fuse blows or the transceiver stops functioning, track down the source of the problem, if possible, and replace the damaged fuse with a new, rated one.

- Fuse rating: 10 A

■ Cleaning

If the transceiver becomes dusty or dirty, wipe it clean with a dry, soft cloth.



AVOID the use of solvents such as benzene or alcohol, as they may damage transceiver surfaces.

5 CONNECTIONS AND MAINTENANCE

■ Connections

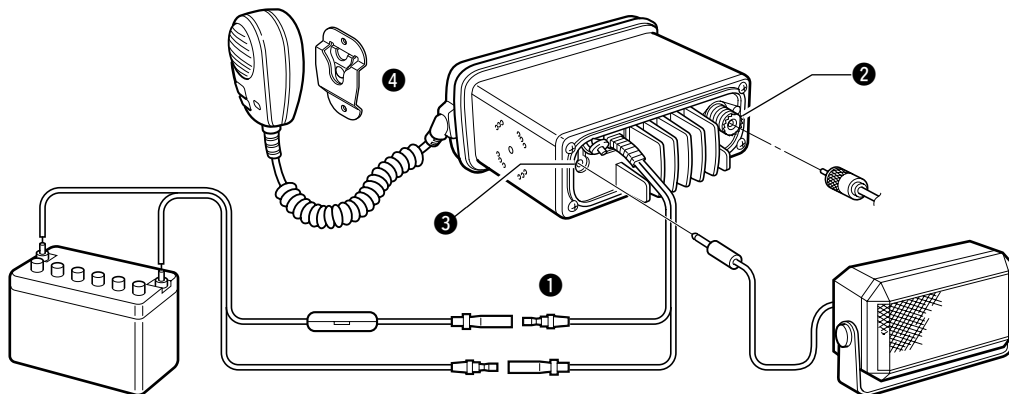

❶ DC POWER CONNECTOR

Connects the supplied DC power cable from this connector to an external 12 V DC power source.

❷ ANTENNA CONNECTOR

Connects a marine VHF antenna with a PL-259 connector to the transceiver.

⚠ **CAUTION:** Transmitting without an antenna will damage the transceiver.

❸ EXTERNAL SPEAKER JACK

Connects to an external speaker. See *OPTIONS* on p. 19 for available external speakers.

❹ MICROPHONE HANGER

Rest the microphone on the hanger when not in use.

■ Mounting the transceiver

The universal mounting bracket supplied with your transceiver allows overhead or dashboard mounting. Please read the following instructions carefully.

- Mount the transceiver securely with the 2 supplied screws (M5 × 20) to a surface which is more than 10 mm thick and can support more than 5 kg.
- Mount the transceiver so that the face of the transceiver is at 90° to your line of sight when operating it.
 - ☞ **CAUTION: KEEP** the transceiver and microphone at least 1 meter away from your vessel's magnetic navigation compass.
 - ☞ **NOTE:** Check the installation angle; the function display may not be easy to read at some angles.

DASHBOARD MOUNTING (with optional MB-69)

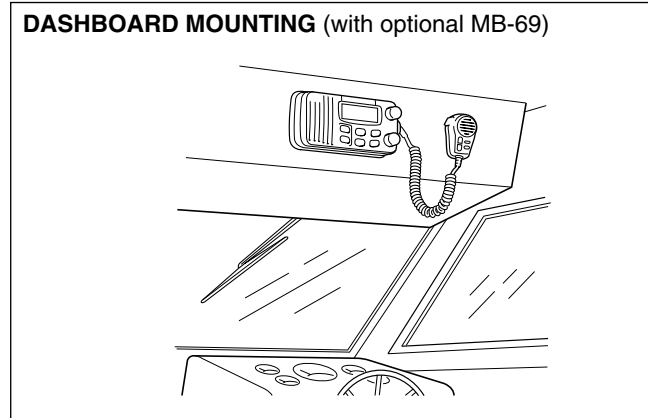

OVERHEAD MOUNTING

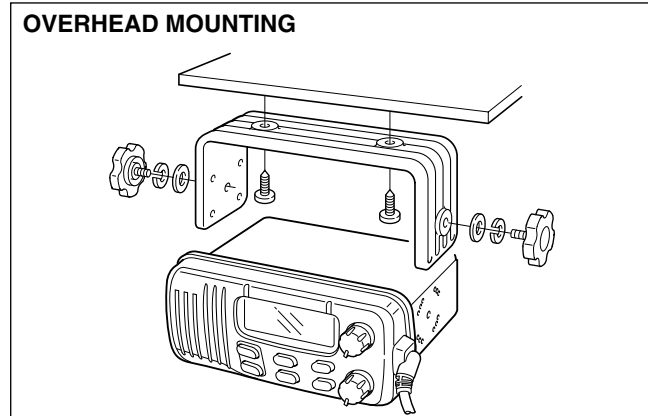

5 CONNECTIONS AND MAINTENANCE

■ Dimensions

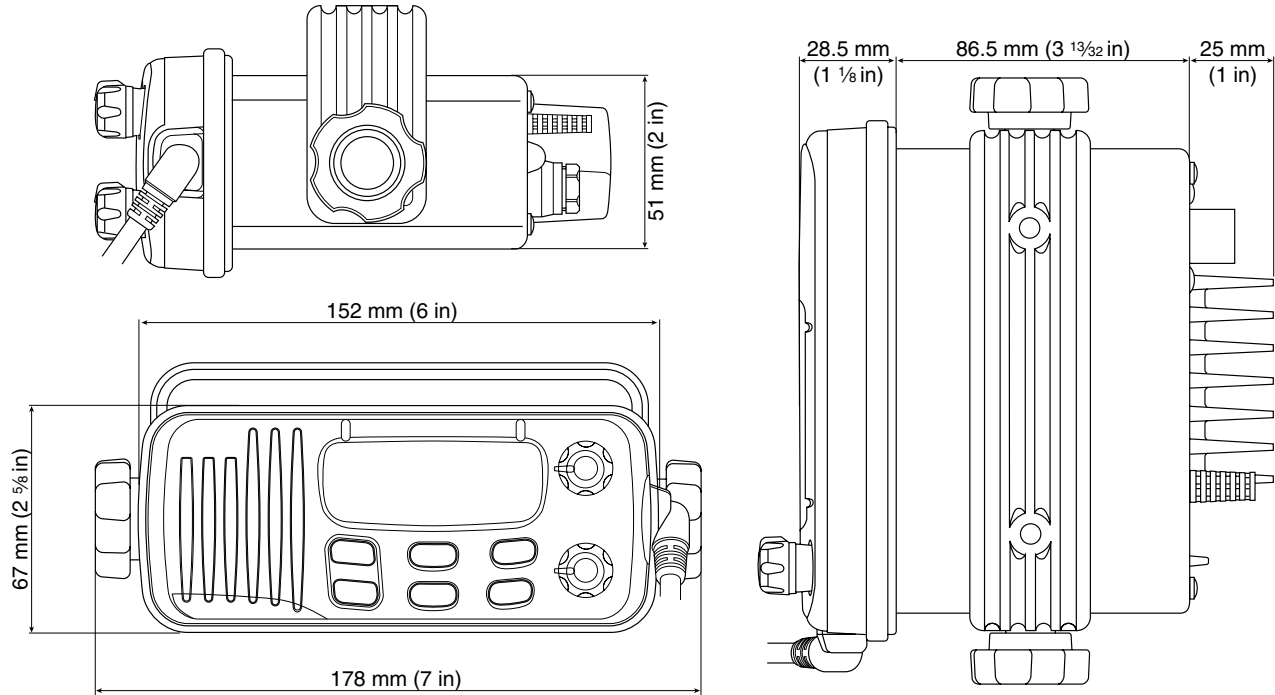

PROBLEM	POSSIBLE CAUSE	SOLUTION	REF.
No power comes on.	<ul style="list-style-type: none"> • Power cord not connected properly. • Blown fuse. 	<ul style="list-style-type: none"> • Check the power cord connection. • Check the polarity of the power connection, then, replace the fuse. 	<p>p. 14</p> <p>p. 13</p>
No sound comes from the speaker.	<ul style="list-style-type: none"> • [SQUELCH] is rotated too far clockwise. 	<ul style="list-style-type: none"> • Rotate [SQUELCH] counterclockwise to a suitable position. 	p. 7
No beeps sound even when a switch is pushed.	<ul style="list-style-type: none"> • Beep function is turned OFF. 	<ul style="list-style-type: none"> • Set beeps to ON in SET mode. 	p. 12
Sensitivity is low and only strong signals are audible.	<ul style="list-style-type: none"> • [SQUELCH] is rotated too far clockwise. • Antenna feedline or the antenna connector solder has poor contact or is short circuited. 	<ul style="list-style-type: none"> • Rotate [SQUELCH] counterclockwise to a suitable position. • Check, and if necessary, replace the feedline or solder the antenna connector again. 	<p>p. 7</p> <p>p. 14</p>
Transmitting is impossible or high power cannot be selected.	<ul style="list-style-type: none"> • Transmission is restricted on some channels. 	<ul style="list-style-type: none"> • Change channels. 	p. 18
Desired channel cannot be selected.	<ul style="list-style-type: none"> • Different channel group is selected. 	<ul style="list-style-type: none"> • Push [CH/WX] + [H/L] to select the appropriate channel group (U.S.A., INT or CAN). 	p. 6
No display backlighting.	<ul style="list-style-type: none"> • Backlight function is turned OFF. 	<ul style="list-style-type: none"> • While pushing [H/L • DIM], push [UP]/[DN] to select the desired brightness. 	p. 10
Scan does not start.	<ul style="list-style-type: none"> • No "TAG" channels are programmed. 	<ul style="list-style-type: none"> • Set channels to be scanned as "TAG" channels. 	p. 9

VHF MARINE CHANNEL LIST

Channel number			Frequency (MHz)	
USA	INT	CAN	Transmit	Receive
	01	01	156.050	160.650
01A			156.050	156.050
	02	02	156.100	160.700
02A			Guard	Guard
	03	03	156.150	160.750
03A			156.150	156.150
	04		156.200	160.800
		04A	156.200	156.200
	05		156.250	160.850
05A		05A	156.250	156.250
06	06	06	156.300	156.300
	07		156.350	160.950
07A		07A	156.350	156.350
08	08	08	156.400	156.400
09	09	09	156.450	156.450
10	10	10	156.500	156.500
11	11	11	156.550	156.550
12	12	12	156.600	156.600
13* ²	13	13* ¹	156.650	156.650
14	14	14	156.700	156.700
15* ²	15* ¹	15* ¹	156.750	156.750
16	16	16	156.800	156.800
17* ¹	17	17* ¹	156.850	156.850
	18		156.900	161.500
18A		18A	156.900	156.900

Channel number			Frequency (MHz)	
USA	INT	CAN	Transmit	Receive
	19		156.950	161.550
19A		19A	156.950	156.950
20	20	20* ¹	157.000	161.600
20A			157.000	157.000
	21	21	157.050	161.650
21A		21A	157.050	157.050
	22		157.100	161.700
22A		22A	157.100	157.100
	23	23	157.150	161.750
23A			157.150	157.150
24	24	24	157.200	161.800
25	25	25	157.250	161.850
26	26	26	157.300	161.900
27	27	27	157.350	161.950
28	28	28	157.400	162.000
	60	60	156.025	160.625
60A			Guard	Guard
	61		156.075	160.675
61A		61A	156.075	156.075
	62		156.125	160.725
		62A	156.125	156.125
	63		156.175	160.775
63A			156.175	156.175
	64	64	156.225	160.825
64A		64A	156.225	156.225

Channel number			Frequency (MHz)	
USA	INT	CAN	Transmit	Receive
	65		156.275	160.875
65A	65A	65A	156.275	156.275
	66		156.325	160.925
66A	66A	66A* ¹	156.325	156.325
67* ²	67	67	156.375	156.375
68	68	68	156.425	156.425
69	69	69	156.475	156.475
70* ³	70* ³	70* ³	156.525	156.525
71	71	71	156.575	156.575
72	72	72	156.625	156.625
73	73	73	156.675	156.675
74	74	74	156.725	156.725
75	75	75	Guard	Guard
76	76	76	Guard	Guard
77* ¹	77	77* ¹	156.875	156.875
	78		156.925	161.525
78A		78A	156.925	156.925
	79		156.975	161.575
79A		79A	156.975	156.975
	80		157.025	161.625
80A		80A	157.025	157.025
	81		157.075	161.675
81A		81A	157.075	157.075
	82		157.125	161.725
82A		82A	157.125	157.125

Channel number			Frequency (MHz)	
USA	INT	CAN	Transmit	Receive
	83	83	157.175	161.775
83A		83A	157.175	157.175
84	84	84	157.225	161.825
84A			157.225	157.225
85	85	85	157.275	161.875
85A			157.275	157.275
86	86	86	157.325	161.925
86A			157.325	157.325
87	87	87	157.375	161.975
87A			157.375	157.375
88	88	88	157.425	162.025
88A			157.425	157.425

WX channel	Frequency (MHz)	
	Transmit	Receive
01	RX only	162.550
02	RX only	162.400
03	RX only	162.475
04	RX only	162.425
05	RX only	162.450
06	RX only	162.500
07	RX only	162.525
08	RX only	161.650
09	RX only	161.775
10	RX only	163.275

*¹Low power only. *²Momentary high power. *³Receive only.

NOTE: Simplex channels 3, 21, 23, 61, 64, 81, 82 and 83 **CANNOT** be lawfully used by the general public in USA waters.

■ Specifications

General

- Frequency coverage : Transmit 156–157.5 MHz
Receive 156–163 MHz
- Usable channels : All USA, international and Canadian channels plus 10 weather channels
- Mode : 16K0G3E
- Power supply requirement : 13.8 V DC $\pm 10\%$ (negative ground)
- Current drain : Transmit
(at 13.8 V DC) high power 6.0 A
Receive
max. audio output 1.2 A
- Frequency stability : ± 10 ppm (-20°C to $+60^{\circ}\text{C}$)
- Usable temperature range : -20°C to $+60^{\circ}\text{C}$; -4°F to $+140^{\circ}\text{F}$
- Dimensions : 152(W) \times 67(H) \times 144(D) mm
(projections not included) 6(W) \times 2 $\frac{5}{8}$ (H) \times 5 $\frac{2}{3}$ (D) in
- Weight : 900 g; 2 lb

Transmitter

- Output power : High 25 W Low 1 W
- Modulation system : Variable reactance
frequency modulation
- Max. frequency deviation : ± 5 kHz
- Spurious emissions : Less than -70 dB
- Microphone impedance : 600 Ω

Receiver

- Receive system : Double-conversion
superheterodyne
- Intermediate frequencies : 1st 21.7 MHz
2nd 450 kHz
- Sensitivity : 0.3 μV at 12 dB SINAD typ.
- Intermodulation rejection : Typical 70 dB
- Adjacent channel selectivity : Typical 70 dB
- Spurious response rejection ratio : Typical 70 dB
- Audio output power : Typical 4 W at 10%
(at 13.8 V DC) distortion with a 4 Ω load
- Audio output impedance : 4 Ω

■ Options

MB-69 FLUSH MOUNT

For mounting the IC-M45 to a panel. Available in black or white.

HM-124B/W SMART MICROPHONE

Optional microphone same as supplied. (W: white, B: black)

SP-5 EXTERNAL SPEAKER

A large, external speaker for superior audio output.

SP-10 EXTERNAL SPEAKER

A compact, external speaker. Features easy installation.

Count on us!

A-5581D-1US-①
Printed in Japan
© 1999 Icom Inc.

Icom Inc.
1-1-32 Kamiminami, Hirano-ku, Osaka 547-0003 Japan